

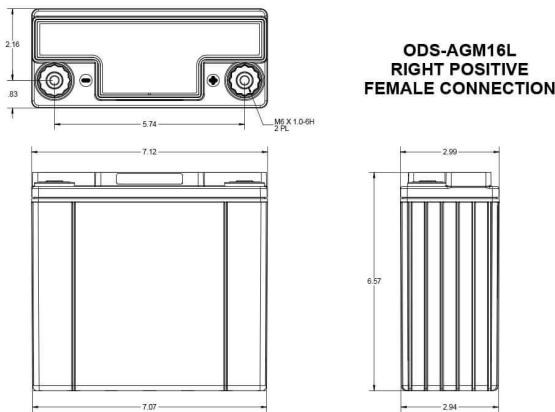

## Drawings & Terminal Position



## Handling and Storage

- Can be mounted or stored in any orientation except inverted
- 2-years storage life at 77°F (25°C) without needing to charge. Recharge when the OCV is <12.6V (50% SOC).
- Classified as non-spillable and approved as non-hazardous cargo for ground, sea and air transportation in accordance with the requirements of IMDG (International Maritime code for Dangerous Goods) and ICAO (International Civil Aviation Organisation)

## Charging and Self-Discharge

Type of charging curve	IUU
Charger voltage at 68°F (20°C)	14.4V to 14.8V
Self-discharge per month at 68°F (20°C)	1.25%
Self-discharge per month at 104°F (40°C)	5%
80% depth of discharge cycles	400

## Technical Data Sheet

### ODS-AGM16L

(PC680)

#### Battery Type

- Group 16 Absorbed Glass Mat (AGM) battery with Thin Plate Pure Lead (TPPL)
- Up to 400 cycles at 80% depth of discharge
- Advanced dual purpose battery for engine start and deep cycle use

#### Power and Performance

Voltage	12V
Pulse (5 second) Hot Cranking Amps (PHCA)	520A
Cold Cranking Amps (CCA)	170A
HCA	350A
MCA	280A
20Hr Nominal Capacity (Ah)	16Ah
10Hr Nominal Capacity (Ah)	16Ah
Reserve Capacity Minutes	24 mins
Terminal	M6 Receptacle
Torque Spec in-lbs (Nm max)	50 (5.6)
Internal Resistance (mΩ)	7 mΩ
Short Circuit (A)	1800A

#### Dimensions and Weight

Length	7.2 in / 183 mm
Width	3 in / 76 mm
Height (terminals included)	6.4 in / 163 mm
Height (container)	6.6 in / 168 mm
Weight	15.4 lbs / 7 kg

#### Temperature

Operating temperature range	-40°F / -40°C to 113°F / +45°C
Optimum storage temperature	68°F / +20°C

#### Accreditations

The management systems governing the manufacture of this product are ISO 9001 and ISO 14001 certified.

\*Cold Start Performance S.A.E J537 Apr 2016



**EnerSys World Headquarters**  
2366 Bernville Road  
Reading, PA 19605, USA  
Tel: +1-800-964-2837

**EnerSys EMEA**  
EH Europe GmbH  
Baarerstrasse 18  
6300 Zug, Switzerland

**EnerSys Asia**  
152 Beach Road  
#11-08 Gateway East  
Building  
Singapore 189721  
Tel: +65 6416 4800

Want more info?  
Scan code to access  
the ODYSSEY® Battery  
Literature Library

